



INFINITY

All Metal Piping Systems

INFINITE ADVANTAGES, INFINITE POSSIBILITIES.

Imagine a solid metal piping system that offers superior strength within a lightweight design. A system that's easy to install, yet ensures high performance and versatility. At Applied Systems Technologies, that's just what we did to create Infinity - the first all-metal, quick-connect piping system at an affordable price.

Heralded for its innovative design, Infinity offers the performance of heavy, traditional steel piping, at the cost of systems using plastic. Its revolutionary lock-and-seal design ensures a totally safe, leak-free system for all compressed air, vacuum, and inert gas applications.

Getting Down to Brass Facts

The heart of Infinity is solid brass, nickel-plated fittings that make the system easy to use and install. Infinity's powder-coated aluminum pipes are so light, they can be handled and installed by one person. Yet when coupled with solid brass fittings, the system yields unbeatable performance and reliability.

Making Connections That Last

Unlike plastic piping systems which fail with age and wear, Infinity provides reliability and durability that can only be achieved through an all-metal system - plus some unique advantages.

- **Fittings can be disconnected and reconnected for reuse.**
- **Leak-free connectors provide an immediate, unbreakable seal.**
- **Lightweight piping remains unaffected by contaminants in the air.**

Installation That's a Snap

Infinity offers the easiest, fastest installation available. There's no welding, gluing or threading, and very little skill is needed for a professional installation. In fact, a simple pipe cutter and de-burring pipe reamer are the only tools required.

“Having a totally metal design provides an integrity that cannot be matched by any other system.”

Ready for Anything

With six different piping sizes, Infinity is a sure fit for virtually any industrial and OEM application, including aerospace, automotive, chemical processing, electronics, engineering, food and beverage, packaging, pharmaceuticals, and textiles. Our standard, color-coded design affords three separate systems that can be easily identified by staff members:

- **Blue for compressed air**
- **Grey for vacuum**
- **Black for inert gases**

TECHNICAL CHARACTERISTICS

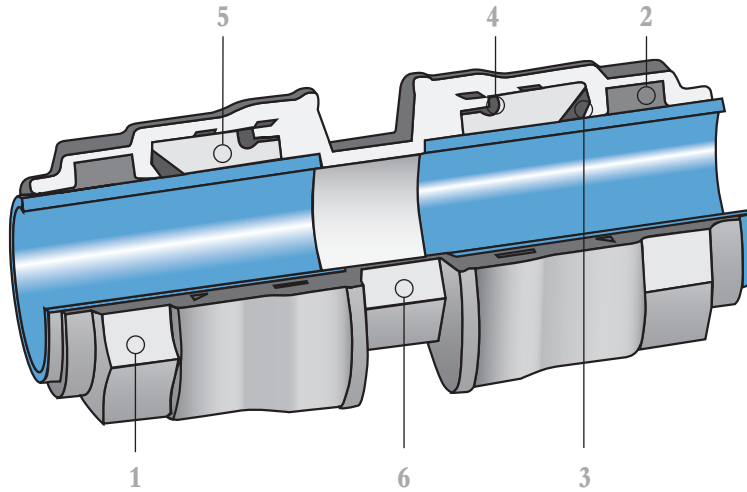

Component part and materials	
1 Nut: Nickel-Plated Brass	4 O-Ring Seal Made in NBR
2 Seal: High Nitrile	5 Safety Ring: Technopolymeric
3 Clamping Washer: Inox AISI 304	6 Body: Nickel-Plated Brass

Temperatures
Minimum temperature -20°C (-4°F)
Maximum temperature +80°C (176°F)
Pressures
Minimum pressure -0.99 bar (-29.6Hg)
Maximum pressure 15 bar (220psi)
Fire resistance
The system does not stroke or propagate any fires
Compatible fluids and gases
Compressed Air
Vacuum
Inert Gases
Threads
Male threads taper in conformity with ISO
Female threads in conformity with ISO 228

TECHNICAL CHARACTERISTICS PERTINENT TO THE TUBES

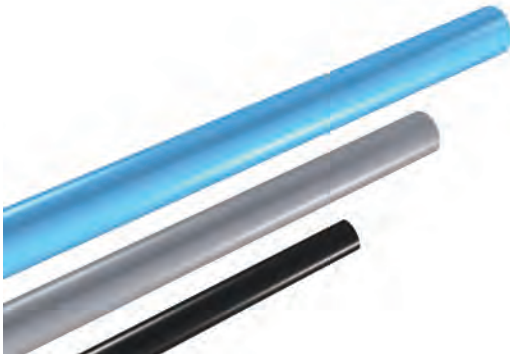

90000 Calibrated Aluminum Piping

Outside	Pressure	Weight	Length
mm (in.)	bar / PSI	lbs./ft.	ft.
20 (0.75")	15 / 220	0.159	16'
25 (1")	15 / 220	0.202	16'
32 (1.25")	15 / 220	0.262	16'
40 (1.5")	15 / 220	0.331	16'
50 (2")	15 / 220	0.592	16'
63 (2.5")	15 / 220	0.623	16'

EXTRUDED ALUMINUM	UNI 9006/1 Al Mg 0.5 Si 0.4 Fe 0.2
CHEMICAL COMPOSITION	Si: 0.3 ÷ 0.6 - Mg: 0.35 ÷ 0.6 - Fe: 0.10 ÷ 0.30
DESIGNATIONS UNI EN 573 - 3	EN AW 6063
HEAT TREATMENT	BONIFICATO "T5"/DRAINED "T5"
SURFACE TREATMENT	Electrostatic painting
SPECIFIC WEIGHT	2.70 Kg/dm ³
SPECIFIC RESISTANCE	3.25 μΩ cm
THERMAL CONDUCTIVITY	1.75 W/(cm °K)
EXPANSION COEFFICIENT	0.024 mm/(m °C)
SPECIFIC HEAT AT 100°C (212°F)	0.92 J/(g °K)
BEARING TENSILE STRESS	205 N/mm ²
COEFFICIENT OF ELASTICITY	66000 N/mm ²
PROPORTIONALITY DEVIATION LOAD	165 N/mm ²
BRINELL HARDNESS	60 ÷ 70 HB
MELTING POINT	600°C (1112°F)
PERCENTAGE ELONGATION	10 %

INSTALLATION OF PIPING

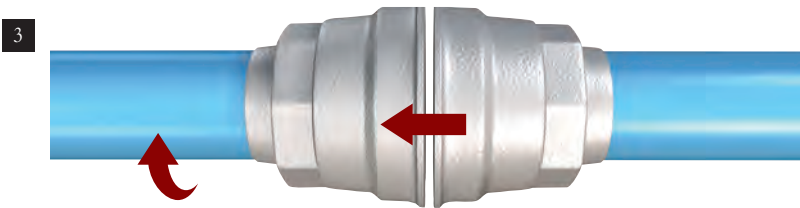
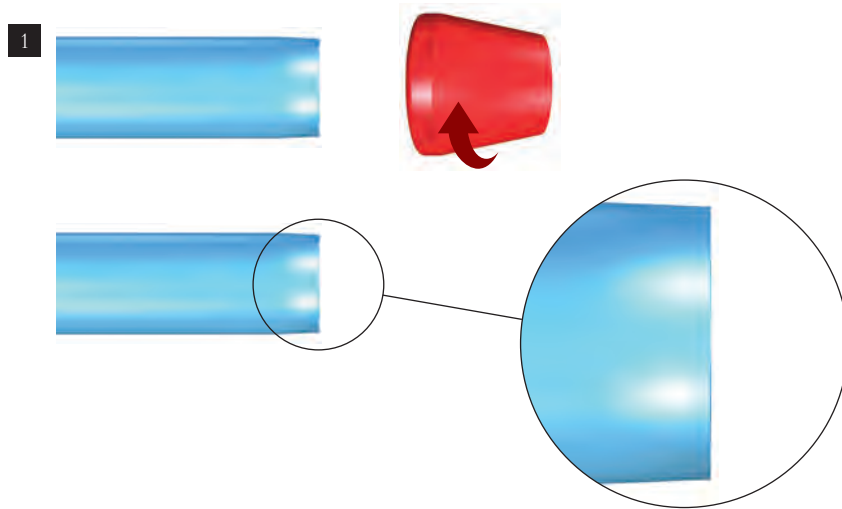

IMPORTANT - Only for installation of piping diameter 50 and 63

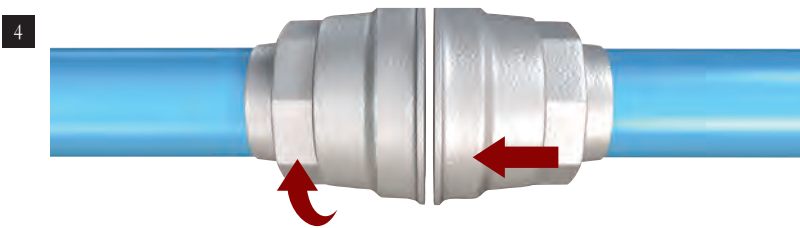

1. Remove burrs from the outside diameter of the tube. Clean and remove any shavings.
2. Add oil on tube before inserting the fitting. (Adding oil is not essential. It is only to make insertion of tubing easier during assembly)
3. Fittings D20, D25, D32 and D40mm are supplied fully assembled. Insert the tube into the fitting. To make insertion easier, rotate the tube on itself while making the connection. Be sure tubing is securely inserted in the fitting.

Diameter	Torque
20	300 cN.m (26in-lbs)
25	300 cN.m (26in-lbs)
32	400 cN.m (35in-lbs)
40	650 cN.m (58in-lbs)

4. Only for tube diameters D50 and D63mm. To facilitate installation, fittings are supplied with unscrewed nuts. Once the tube is inserted into the fitting, tighten the nuts to the torque specified below.

Diameter	Torque
50	65 N.m (48 ft-lbs)
63	65 N.m (48 ft-lbs)

5. Before pressurizing a piping system, please read and fully understand the requirements of the **“INFINITY TEST PROCEDURE.”** Failure to comply with the requirements of the test procedure could lead to serious injury or property damage.

An INFINITY TEST PROCEDURE document is provided with every shipment of parts and can also be downloaded from our website - www.appliedsystemtech.com



FLOW RATES THROUGH INFINITY PIPING

Pipe Internal Diameter		CFM	CFM	CFM	CFM
mm	(in.)	@ 125psi	@ 150psi	@ 175psi	@ 220psi
20mm	(0.75")	36	39	42	48
25mm	(1")	76	81	88	99
32mm	(1.25")	146	158	171	189
40mm	(1.5")	266	291	310	348
50mm	(2")	476	526	565	627
63mm	(2.5")	881	965	1047	1153

Flow rates are based on a 1psi pressure drop per 100ft run of pipe and couplings in a “straight line.”
For loop systems, flow rates can be doubled.

Example:

100ft run of 2" pipe flows 476cfm at 125psig with a pressure drop of 1psig. If a system is designed in a loop configuration, a flow of 952cfm with a pressure loss of 1psig per 200ft of piping and couplings can be achieved. The 1psi pressure loss will only occur if the compressor system is flowing the maximum flow capacity of the piping selected.

Flows are measured at standard atmospheric conditions: 1013mbar (14.7psi) at 20°C - (68°F).

It is vital that the size of the piping between the compressors and the connection of the loop system can flow the full capacity of the combined compressor output.

Testing

Infinity tube fittings are tested in accordance with the requirements of ANSI B31.1 (American National Standards Institute) Power Piping Systems.

All Infinity products have been tested and exceed the requirements of ANSI B31.1.

Infinity product provides a 5X safety factor above recommended safe working pressure/temperatures.

COLOR CODED TUBING FOR EASE OF IDENTIFICATION

90000–AIR Compressed Air Piping - Blue

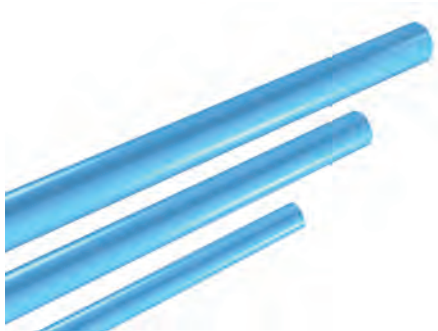

Bore size mm (in.)	Pressure psi	Flow rate @ 125psi cfm	Weight lbs./ft.	Length ft.	Part Number
20 (0.75")	220	36	0.159	16	9000-20-AIR-BLUE
25 (1")	220	76	0.202	16	9000-25-AIR-BLUE
32 (1.25")	220	146	0.262	16	9000-32-AIR-BLUE
40 (1.5")	220	266	0.331	16	9000-40-AIR-BLUE
50 (2")	220	476	0.592	16	9000-50-AIR-BLUE
63 (2.5")	220	881	0.623	16	9000-63-AIR-BLUE

90000–VACUUM Vacuum Piping - Grey

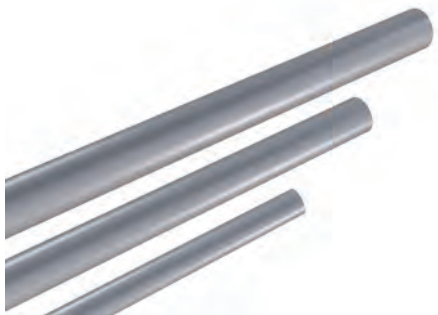

Bore size mm (in.)	Pressure psi	Flow rate @ 125psi cfm	Weight lbs./ft.	Length ft.	Part Number
20 (0.75")	220	36	0.159	16	9000-20-VAC-GREY
25 (1")	220	76	0.202	16	9000-25-VAC-GREY
32 (1.25")	220	146	0.262	16	9000-32-VAC-GREY
40 (1.5")	220	266	0.331	16	9000-40-VAC-GREY
50 (2")	220	476	0.592	16	9000-50-VAC-GREY
63 (2.5")	220	881	0.623	16	9000-63-VAC-GREY

90000–GAS Inert Gases Piping - Black



Bore size mm (in.)	Pressure psi	Flow rate @ 125psi cfm	Weight lbs./ft.	Length ft.	Part Number
20 (0.75")	220	36	0.159	16	9000-20-GAS-BLACK
25 (1")	220	76	0.202	16	9000-25-GAS-BLACK
32 (1.25")	220	146	0.262	16	9000-32-GAS-BLACK
40 (1.5")	220	266	0.331	16	9000-40-GAS-BLACK
50 (2")	220	476	0.592	16	9000-50-GAS-BLACK
63 (2.5")	220	881	0.623	16	9000-63-GAS-BLACK

90011 Male Thread Connectors

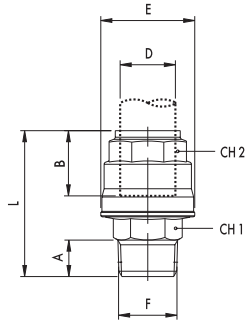

D	F	A	B	E	L	CH1	CH2	Part Number
20	0.5"	14	32.5	34.5	56	22	30	90011-20-08
25	0.75"	16.5	38.5	42.5	66	27	35	90011-25-12
32	1"	19	46	52	76.5	34	45	90011-32-16
40	1.5"	21.5	52	63	89.5	45	55	90011-40-24
50	1.5"	21.5	63.5	73	105	50	65	90011-50-24
63	2"	24	75.5	92	124	65	70	90011-63-32

* Threads in npt.
Other dimensions are measured in mm.

90040 Straight Unions

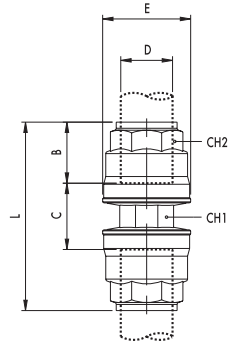

D	B	C	E	L	CH1	CH2	Part Number
20	32.5	12.5	34.5	76.5	21	30	90040-20
25	38.5	13.5	42.5	90.5	26	35	90040-25
32	46	14.5	52	106.5	32	45	90040-32
40	52	21	63	125	41	55	90040-40
50	63.5	21.5	73	148.5	50	65	90040-50
63	75.5	25	92	176.5	65	70	90040-63

* All dimensions are measured in mm.

90130 90° Union Elbows

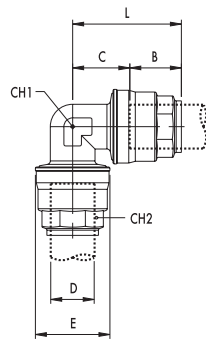

D	B	C	E	L	CH1	CH2	Part Number
20	32.5	18	34.5	51	21	30	90130-20
25	38	23	42.5	61.5	26	35	90130-25
32	46	28	52	74.5	34	45	90130-32
40	52	34	63	86.5	41	55	90130-40
50	63.5	40.5	73	104	50	65	90130-50
63	75.5	52	92	127.5	65	70	90130-63

* All dimensions are measured in mm.

90140 45° Union Elbow

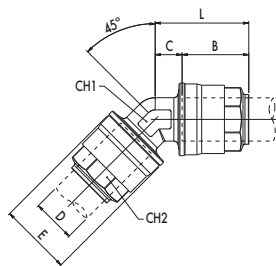

D	B	C	E	L	CH1	CH2	Part Number
20	31.5	12.5	34.5	44	21	30	90140-20
25	38.5	13.5	42.5	52	26	35	90140-25
32	46	15	52	61	34	45	90140-32
40	52	18	63	70	41	55	90140-40
50	63.5	20	73	83.5	50	65	90140-50
63	59	24	92	83	65	70	90140-63

90230 Equal Tee

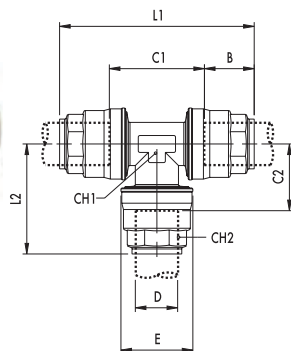

D	E	B	C1	C2	L1	L2	CH1	CH2	Part Number
20	34.5	32.5	32.5	21.5	98	54.5	21	30	90230-20
25	42.5	38	37.5	26	113.5	65	26	35	90230-25
32	52	46	46.5	31.5	138.5	77	34	45	90230-32
40	63	52	55.5	38	159.5	90	41	55	90230-40
50	73	63.5	69	44.5	196	108	50	65	90230-50
63	92	75.5	87	55.5	238.5	131	65	70	90230-63

* All dimensions are measured in mm.

OUTLET/REDUCING TEE FITTING

The fitting is a valid alternative to the traditional swan neck, and proves itself as a fast and low-cost solution. The efficient internal system allows air to reach the point-of-use and drain toward the most convenient low point of the system, so that no moisture stays within the main circuit.

This fitting is also an alternative to a traditional goose neck (up and over) take-off point. It prevents water from dropping out of the main piping loop into the drop line. All systems should be installed with a slight gradient to allow moisture to collect at one point in the system. This point should be fitted with a drop line and terminated with a condensate drain.

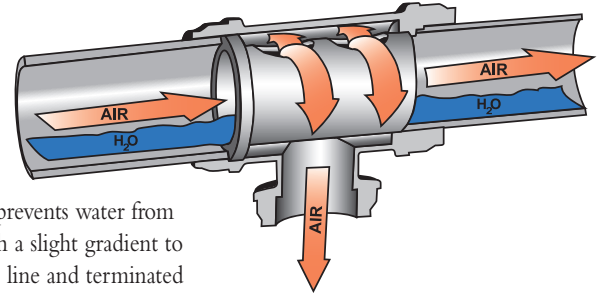

90235 Outlet/Reducing Tee Fitting

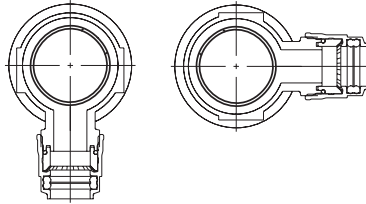

The particular internal geometric shape allows a fitting to be used vertically, as well as horizontally. During horizontal installation, please keep the two internal holes turned up toward the upper side.

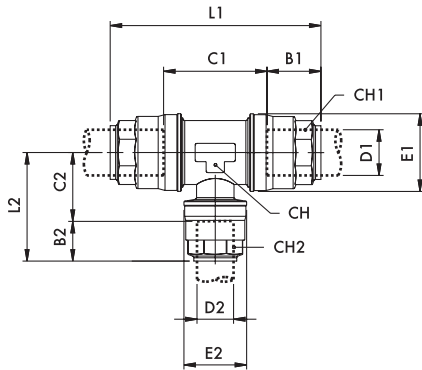

D1	D2	B1	B2	C1	C2	E1	E2	L1	L2	CH	CH1	CH2	Part Number
20	20	32.5	32.5	32.5	21.5	34.5	34.2	98	54.5	21	21	30	90235-20-20
25	20	38	32.5	45.5	26.5	42.5	34.5	121.5	59	35	35	30	90235-25-20
32	20	46	32.5	54.5	30.5	52	34.5	146.5	63	45	45	30	90235-32-20
32	25	46	38	54.5	31.5	52	42.5	146.5	70	45	45	35	90235-32-25
40	20	52.5	32.5	60	33.5	63	34.5	165.5	66	55	55	30	90235-40-20
40	25	52.5	38	60	34.5	63	42.5	165.5	87	55	55	35	90235-40-25
50	20	63.5	32.5	73.5	40.5	73	34.5	201	73	65	65	30	90235-50-20
50	25	63.5	38.5	73.5	41	73	42.5	201	80	65	65	35	90235-50-25
50	32	63.5	46	73.5	41	73	52	201	87.5	65	65	45	90235-50-32
63	20	77	32.5	86	48.5	92	34.5	237.5	81	80	70	30	90235-63-20
63	25	77	38.5	86	49	92	42.5	237.5	88	80	70	35	90235-63-25
63	32	77	46	86	49	92	52	237.5	95.5	80	70	45	90235-63-32

* All dimensions are measured in mm.

90240 Outlet, Saddle Clamp Reducer



Tube mm	Outlet mm	Out-Inches	Part Number
32	20	.75	90240-32-20
32	25	1	90240-32-25
40	20	.75	90240-40-20
40	25	1	90240-40-25
50	20	.75	90240-50-20
50	25	1	90240-50-25
63	20	.75	90240-63-20
63	25	1	9240-63-25

90241 Cutting Tool, Saddle Clamp



Tube mm	Part Number
32-40	90241-32-40
50-63	90241-50-63

90242 Drilling Jig, Saddle Clamp



Tube mm	Part Number
32	90242-32
40	90242-40
50	90242-50
63	90242-63

90260 Drain Assembly

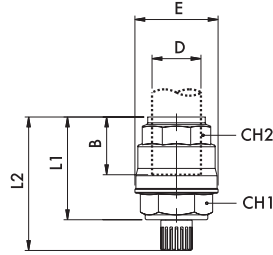

D	B	E	L1	L2	CH1	CH2	Part Number
25	38	42.5	57.5	72	32	35	90260-25
32	46	52	67.5	82	38	45	90260-32
40	52	63	77	91.5	50	55	90260-40
50	63.5	73	86.5	101	55	65	90260-50
63	75.5	92	100.5	115	65	70	90260-63

90601 Outlet Elbow c/w Mtg Bracket

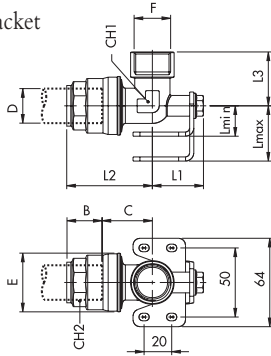

D	F	B	C	E	L1	L2	L3	Lma	x	Lmi	n	Part Number
20	0.5"	32.5	18.5	34.5	35	51	35	40	22	21	30	90601-20-08
25	0.5"	38	23	42.53	7	62	39	40	22	26	35	90601-25-08
32	0.5"	46	28	52	41	74.5	48.5	40	22	34	45	90601-32-08

* Threads in npt.
Other dimensions are measured in mm.

90602 Double Outlet Elbow c/w Mtg Bracket

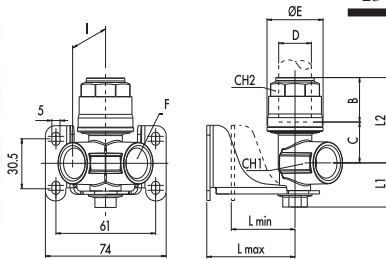

D	F	B	C	E	I	CH1	CH2	L1	L2	L min	L max	Part Number
20	0.5	31.5	20	34.5	28.5	26	30	27	51.5	22	54	90602-20-08
25	0.5	38.5	21	42.5	28.5	26	35	27	59	22	54	90602-25-08

90610 Plug - Cap End Fitting

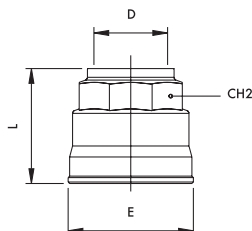

D	L	E	CH2	Part Number
20	33	34.5	30	90610-20
25	39	42.5	35	90610-25
32	46.5	52	45	90610-32
40	53	63	55	90610-40
50	62	73	65	90610-50
63	74.5	92	70	90610-63

* All dimensions are measured in mm.

90620 Reducer, Fitting Body to Tube



Body	Outlet mm	Out-Inches	Part Number
25	20	.75	90620-25-20
32	20	.75	90620-32-20
32	25	1	90620-32-25
40	20	.75	90620-40-20
40	25	1	90620-40-25
40	32	1.25	90620-40-32
50	25	1	90620-50-25
50	32	1.25	90620-50-32
50	40	1.5	90620-50-40
63	40	1.5	90620-63-40
63	50	2	90620-63-50

90626 Stem Adapter (Male)



Body	Inches	Part Number
20mm x .5" npt male		90626-20-08M
20mm x .75" npt male		90626-20-12M
25mm x .5" npt male		90626-25-08M
25mm x .75" npt male		90626-25-12M
25mm x 1" npt male		90626-25-16M
32mm x 1" npt male		90626-32-16M
32mm x 1.5" npt male		90626-32-24M
40mm x 1.5" npt male		90626-40-24M
50mm x 1.5" npt male		90626-50-24M
50mm x 2" npt male		90626-50-32M
63mm x 2" npt male		90626-63-32M
63mm x 2.5" npt male		90626-63-40M

90626 Stem Adapter (female)



Body mm	Inches	Part Number
20	0.5"	90626-20-08

90700 Ball Valve, Tube to Tube

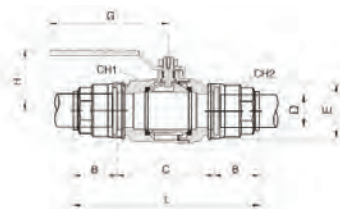

D	B	C	E	L	CH1	CH2	G	H	Part Number
20	31.5	58.5	34.5	121.5	32	30	88	42	90700-20
25	38.5	61.5	42.5	138.5	41	35	106	47.5	90700-25
32	46	75	52	167	50	45	106	53	90700-32
40	52.5	81	63	186	59	55	134	65	90700-40
50	63.5	103	73	230	69	65	134	72.5	90700-50
63	59	126	92	247	92	70	240	111.5	90700-63

82600 Two-way Outlet Y Adaptor

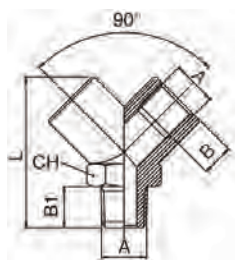

A	B	B1	L	CH	Part Number
NPTf					
0.5"	14	17	58	26	82600-08-08

* Threads in npt.
Other dimensions are measured in mm.

86300/86310 Ball Valves



NPT		Part Number
0.5"	Female / Female Ball Valve	86300-08-08
0.5"	Male / Female Ball Valve	86310-08-08

90810 Hanging/Strut Bracket Pack of 10



Tube mm	Inches	Part Number
20	.75	90810-20-PK-10
25	1	90810-25-PK-10
32	1.25	90810-32-PK-10
40	1.5	90810-40-PK-10
50	2	90810-50-PK-10
63	2.5	90810-63-PK-10

90810 Flush Wall Bracket Pack of 10



Tube mm	Inches	Part Number
20	.75	90810-20-PK10-W
25	1	90810-25-PK10-W
32	1.25	90810-32-PK10-W
40	1.5	90810-40-PK10-W
50	2	90810-50-PK10-W
63	2.5	90810-63-PK10-W

90831 Wire Hanging System (Use with Hanging/Strut Bracket)



20 - 63 mm	Part Number
15 ft. lg pkg 10	90831-15

90810 1/2" Deep Wall Spacer Kit (for use with both hanging/strut & Flush Wall Bracket)



	Part Number
1/2" Deep Wall Spacer	90810-SP-PK-10

* All dimensions are measured in mm.

90830 Cantilever Bracket



H	L	Part Number
4.75"	8.25"	90830

80191 Quick Coupler, Universal Socket



	Part Number
1/4" NPT Male	80191-04
3/4" NPT Male	80191-06
1/2" NPT Male	80191-08
1/4" NPT Female	80192-04
3/4" NPT Female	80192-06
1/2" NPT Female	80192-08

80193 Quick Coupler, Universal Socket



	Part Number
3/8" Hose Barb	80193-06
1/2" Hose Barb	80193-08

80221 Plug



	Part Number
1/4" NPT Male	80221-04
3/8" NPT Male	80221-06
1/2" NPT Male	80221-08

80222 Plug



	Part Number
1/4" NPT Female	80222-04
3/8" NPT Female	80222-06
1/2" NPT Female	80222-08

80223 Plug



	Part Number
1/4" Hose Barb	80223-04
3/8" Hose Barb	80223-06
1/2" Hose Barb	80223-08

90870 Tube Cutter



	Part Number
20 - 63	90870

* All dimensions are measured in mm.

90880 Deburring Tool



	Part Number
20 - 40	90880

* All dimensions are measured in mm.

PMZR PowerMizer - System flow controllers



Flow Rate	Part Number
75scfm	PMZR-75
200 scfm	PMZR-200
1000 scfm	PMZR-1000

ZLD Zero Loss Drain Valve



Flow Rate	Part Number
200	ZLD-200
500	ZLD-500
2000	ZLD-2000
5000	ZLD-5000
18000	ZLD-18000
53000	ZLD-53000

90900 Electronic Drain Valves



	Part Number
1/4" NPT w/Strainer	90900-04
1/2" NPT w/Strainer	90900-08

90601 Outlet Manifold



	Part Number
1/2" in, 1/2" out, plus 4 x 1/2"	90601-MFD
3/4" in, 1/2" out, plus 4 x 1/2"	90602-MFD

90601 Pressure Gauge Kit



	Part Number
2-1/2" stainless steel liquid filled gauge 0-300psi Complete with all mounting components	90601-G

90610 Plugs



	Part Number
O ring sealed plugs	90610-08-NPT

Infinity Water Remover Unit

Removes 99% of Water in Droplet Form



Thread	Flow Rate	Part Number
1/2"	53	WR-50
3/4"	78	WR-75
1"	131	WR-100
1-1/2"	212	WR-150
2"	424	WR-200

* Unit supplied without brackets

Condensate Catcher



Capacity	Connections	Part Number
1 Gallon	1/8," 1/4," and 1/2"	CC1-AST

* All kits are supplied with multiple size connectors to allow easy install

Lockable Exhausting Valves

**OSHA
compliant**



Thread	Flow Rate	Part Number
1/2"	168	IV-50
3/4"	236	IV-75
1"	383	IV-100

* Unit supplied without brackets or muffler

DRI System

Water remover, exhaust valve and 4 point manifold



Thread	Flow Rate	Manifold (In & Base)	Manifold Ports	Part Number
1/2"	53	1/2" in, 1/2" out	4 x 1/2" NPT	DRI-50
3/4"	78	3/4" in, 1/2" out	4 x 1/2" NPT	DRI-75
1"	131	3/4" in, 1/2" out	4 x 1/2" NPT	DRI-100

* Unit supplied without brackets or muffler

IVM Unit

Exhausting valve & 4 point manifold

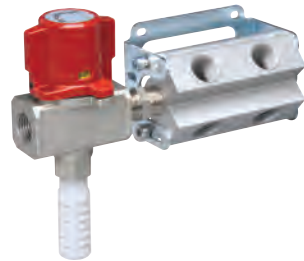

Thread	Flow Rate	Manifold (In & Base)	Manifold Ports	Part Number
1/2"	168	1/2" in, 1/2" out	4 x 1/2" NPT	IVM-50
3/4"	236	3/4" in, 1/2" out	4 x 1/2" NPT	IVM-75

* Unit includes 3 manifold plugs (1/2" NPT) and mounting bracket on manifold

IVWR Unit

Combines water remover and isolation valve



Thread	Flow Rate	Part Number
1/2"	53	IVWR-50
3/4"	78	IVWR-75
1"	131	IVWR-100

* Unit includes single mounting bracket

WRM Unit

Combines water remover and 4 point manifold



Thread	Flow Rate	Manifold (In & Base)	Manifold Ports	Part Number
1/2"	53	1/2" in, 1/2" out	4 x 1/2" NPT	WRM-50
3/4"	78	3/4" in, 1/2" out	4 x 1/2" NPT	WRM-75

* Unit includes 3 manifold plugs (1/2" NPT) and single mounting bracket



10 YEAR GUARANTEE

Applied System Technologies warrants its Infinity pipe and fitting components to be free of leaks due to manufacturing defects for a period of 10 years from date of sale. This Express warranty is in lieu of and excludes all other warranties, guarantees or representations, express or implied, by operation of law or otherwise, including any warranty that the materials are suitable for the buyer's requirements or special use. System must be installed by an AST approved technician.

Applied System Technologies agrees to replace any component proven to have a manufacturing defect.

Applied System Technologies shall not be liable for any consequential damages nor for loss, damage or expenses directly or indirectly arising from the use of the product.





applied system technologies™

The Calhoun Building
9800 West Kinsey Avenue
Suite 135
Huntersville, North Carolina 28078
P. 704.947.6966
F. 704.947.6965

www.appliedsystemtech.com

Nothing contained on these pages is intended to extend any warranty or representation, expressed or implied, regarding the product described herein. Any such warranties or other terms and conditions of sale of products shall be in accordance with Applied System Technologies standard terms and conditions for such products, which are available upon request.

Product improvement is a continuing goal at Applied System Technologies. Designs and specifications are subject to change without notice or obligation.



INFINITY

AST/INF/4